

Spielgerät **Kletternetz**
Artikelnummer **055110500**

Produktbeschreibung (Seite 1)

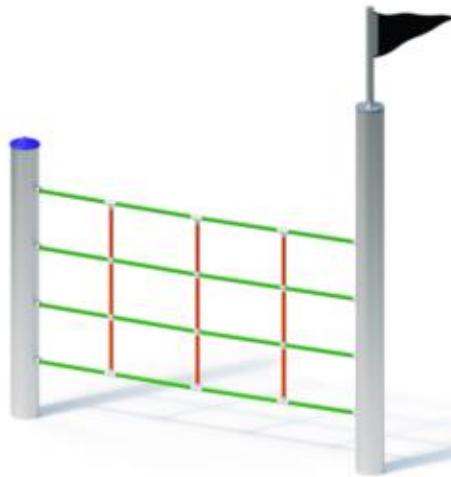

Standpfosten

Standpfosten aus Edelstahlrohr Ø 120 mm mit nicht lösbaren Pfostenkappen aus Edelstahl abgedeckt.

Anbauteile

- Kletternetz 0,75 x 1,60 m rot/grün, Ø 16 mm
- Fahne aus Gummi mit Gewebeeinlage zur Befestigung auf dem Standpfosten

Metallbauteile: Edelstahl. Die modularen Anbauteile leiten ihre Kräfte über eine spezielle Adapterbefestigung direkt in die Standpfosten ein. Die Schraubverbindungen sind gegen unbefugtes Lösen gesichert.

Spielgerät **Kletternetz**
 Artikelnummer **055110500**

<https://kaiser-kuehne.com/product/kletternetz/>

Produktdaten

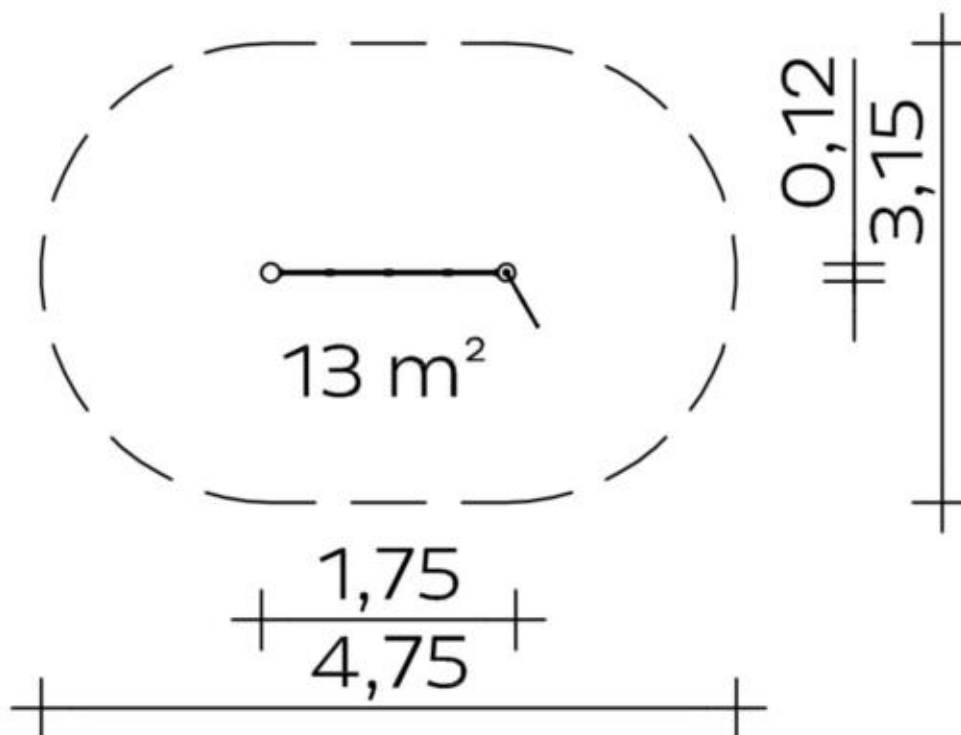







(ohne Maßstab)

Installation

Gerät [m]	L	1,75
	B	0,12
	H	2,05
Mindestraum [m]	L	4,75
	B	3,15
	H	2,05
Aufprallfläche [m ²]		13,00
freie Fallhöhe [m]		1,00
Anzahl Monteure		2
Montagezeit [Std]		1
Hebezeug		Nein
Einzelgewicht [kg]		25
Gesamtgewicht [kg]		55

Nutzung

Einsatzgebiete	öffentliche Spielplätze
Aktivitäten	Klettern Sportliche Aktivität
Altersgruppen	3+
Anzahl Benutzer	4
Inklusion	Einzelspiele  Gleichgewicht  Gruppenspiele  Höhenerfahrung  Koordination  Paralleles Spielen 

Fundamente

L [m]	B [m]	H [m]	Vol [m ³]	Anzahl
0,50	0,50	0,60	0,150	2
			0,300	2

Spielgerät **Kletternetz**
Artikelnummer **055110500**

Varianten

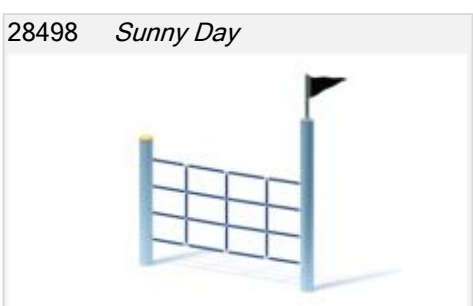
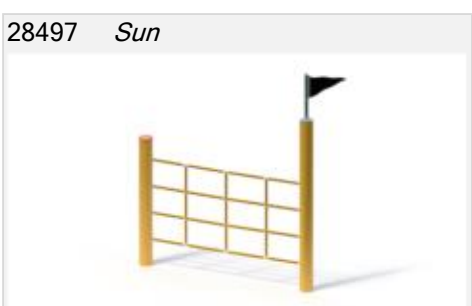
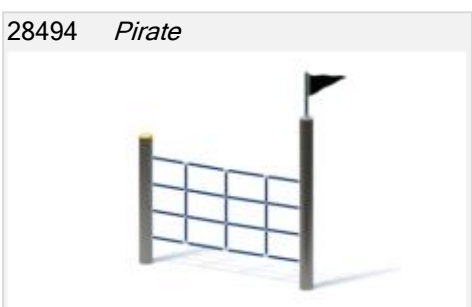
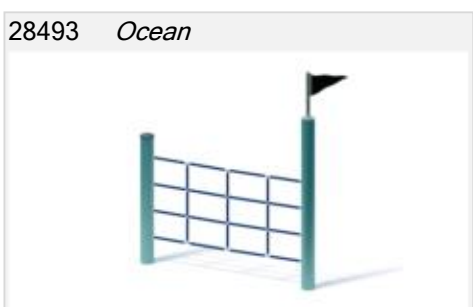
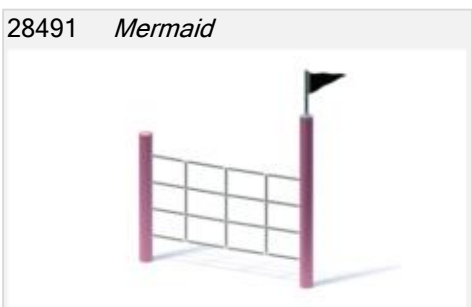
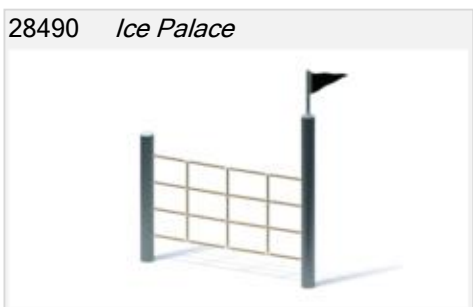
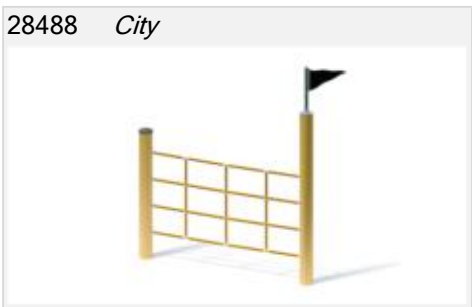
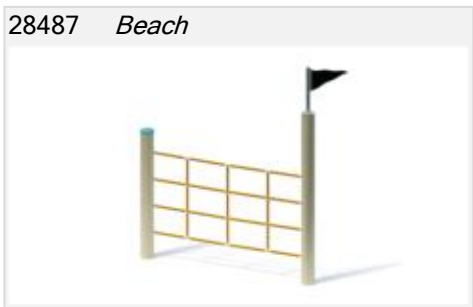
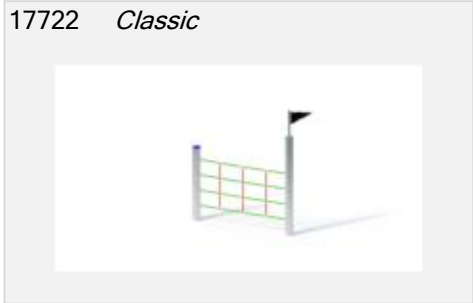

Spielgerät **Kletternetz**
Artikelnummer **055110500**

Varianten

28499 *Sweden*

