

Spielgerät **Innenlauftrommel**
Artikelnummer **045450001A**

Produktbeschreibung (Seite 1)

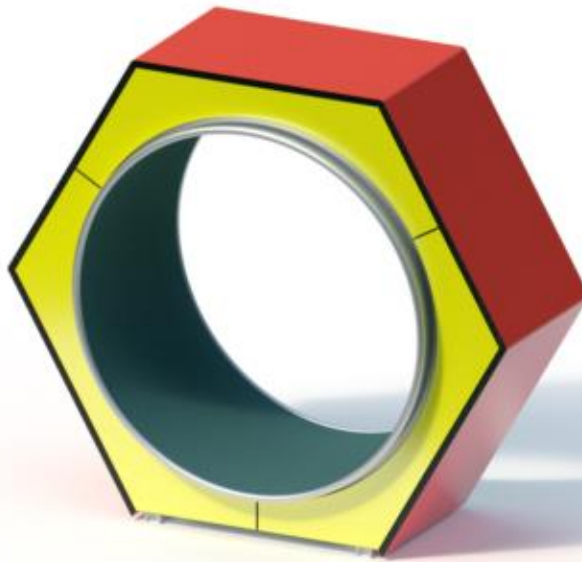

- Gehäuse: Feuerverzinkte Stahlkonstruktion mit mehrfach wälzgelagertem Innenlaufkranz,
Verkleidung aus Hochdrucklaminat 15 mm
- Lauftrommel: Edelstahl
- Lauffläche: EPDM

Spielgerät

Innenlauftrommel

Artikelnummer

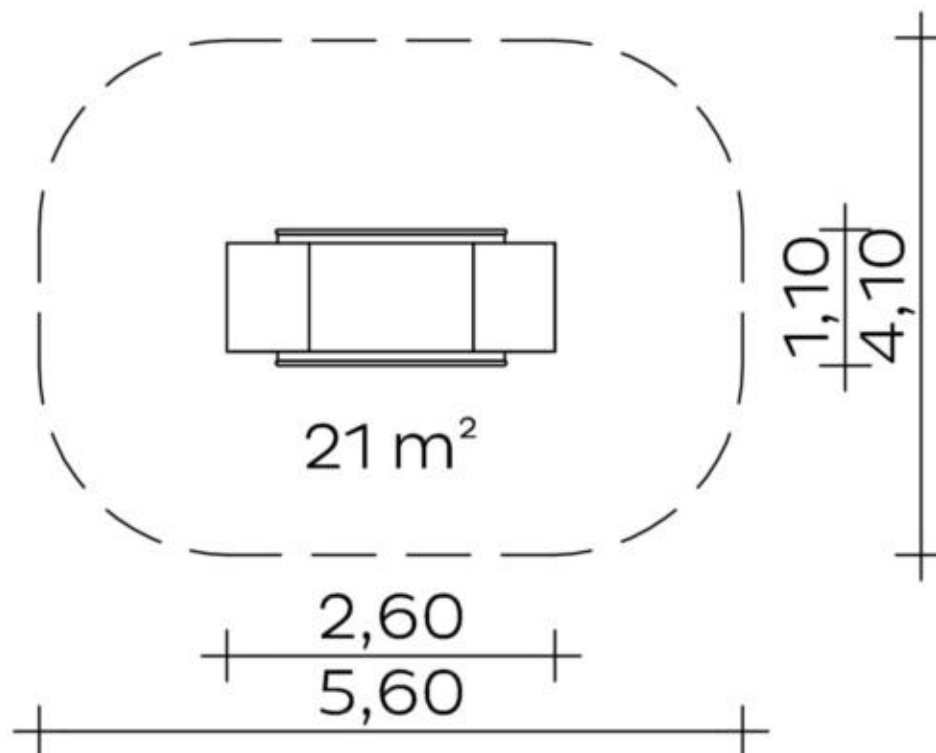
045450001A<https://kaiser-kuehne.com/product/innenlauftrommel/>**Produktdaten**

(ohne Maßstab)

Installation

Gerät [m]	L	2,60
	B	1,10
	H	2,30
Mindestraum [m]	L	5,60
	B	4,10
	H	2,30
Aufprallfläche [m²]		21,00
freie Fallhöhe [m]		0,85
Anzahl Monteure		2
Montagezeit [Std]		2
Hebezeug		Ja
Einzelgewicht [kg]		664
Gesamtgewicht [kg]		675

Nutzung

Einsatzgebiete	öffentliche Spielplätze
Aktivitäten	Bewegungsaktivität
Altersgruppen	6+
Anzahl Benutzer	1

Inklusion**Fundamente**

L [m]	B [m]	H [m]	Vol [m³]	Anzahl
1,40	0,90	0,50	0,630	1
			0,630	1

Spielgerät **Innenlauffrommel**
Artikelnummer **045450001A**

Varianten

17571 *Sunny Day*



17570 *Classic*



18888 *Jungle*



31948 *Aloha*



31949 *Beach*



31950 *City*

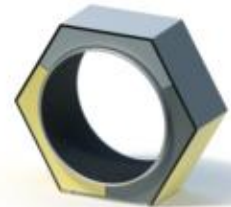

31951 *Coral*



31952 *Ice Palace*

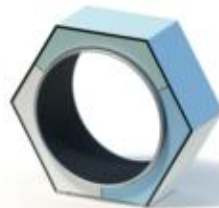

31953 *Mermaid*



31954 *Nature*

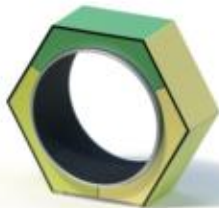

31955 *Ocean*

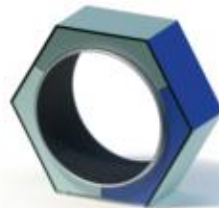

31956 *Pirate*



31957 *Safari*



31958 *Sky*

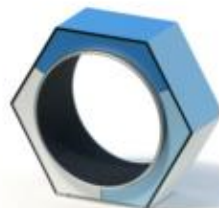

31960 *Sun*



Spielgerät **Innenlauftrommel**
Artikelnummer **045450001A**

Varianten

31961 *Sweden*

