

*free height of fall
(measured at extreme
positions of movement)

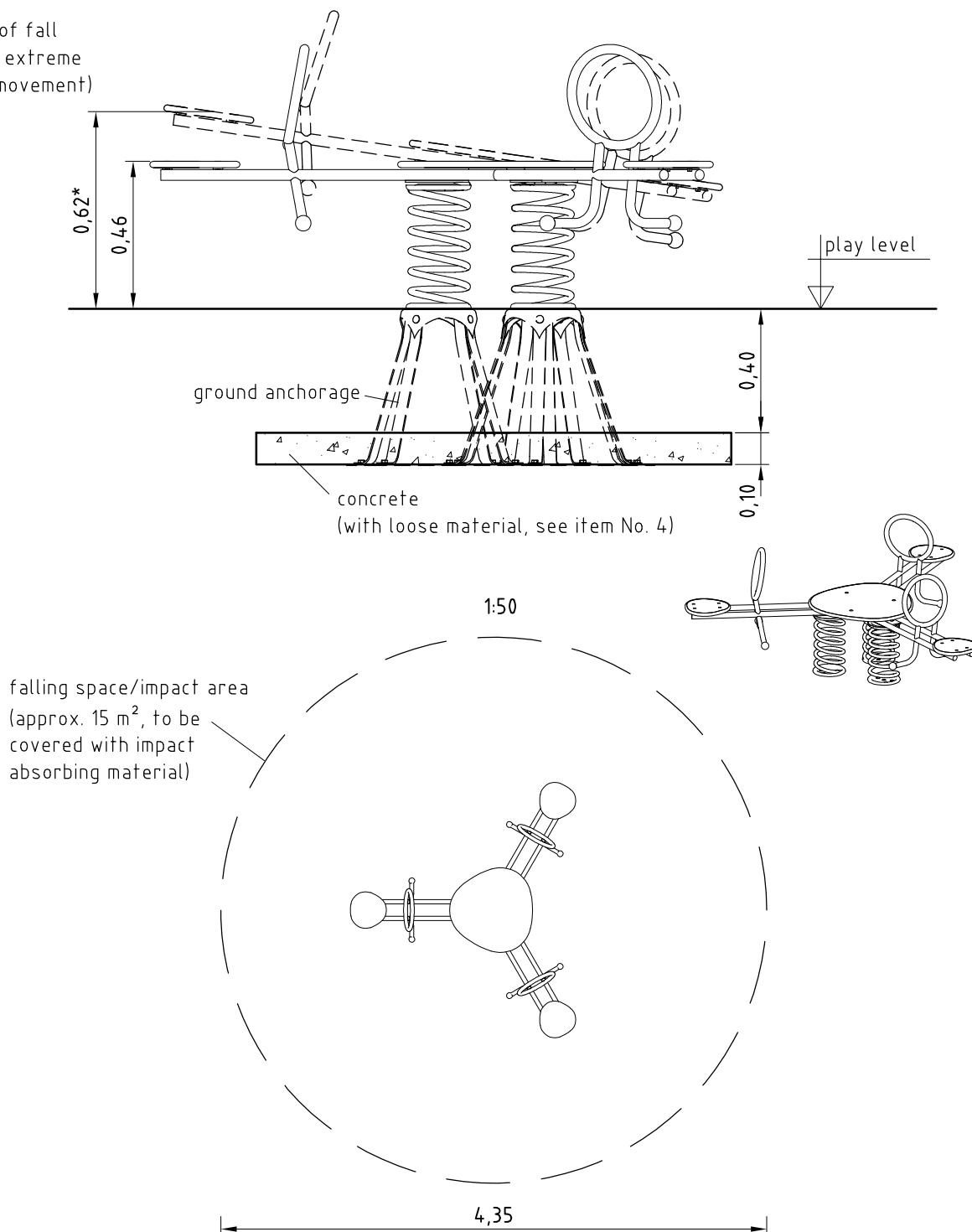

1. Assign a location for the equipment considering the impact area/(falling) space requirements.
2. Excavate soil for ground anchorage, according to drawing. Please note: To achieve maximum stability and a safe installation, a moderate level of soil solubility is required.
3. Put unit with pre-assembled ground anchorage into hole and align it.
4. With loose particulate material (e.g. bark, woodchip, gravel or sand), it is essential to cover the bottom plate of depth anchor with compressed concrete C20/25 of approx. 10 cm thickness. Afterwards, refill the remaining hole up to the top edge of the ground anchorage and compress the soil.
5. The soil characteristics of the impact area surrounding the equipment must have an appropriate level of shock absorption corresponding to a free height of fall of at least 620 mm (according to EN 1176-6).

Please ensure that all special tools supplied (e.g. Allen key for secured Allen screws etc.) and all specific documents which are or may be useful for safety management acc. to EN 1176-7 (e.g. invoice, delivery note, order acknowledgement, installation instructions, maintenance instructions) are forwarded to the persons responsible.