

Instructions for maintenance

© 2009 Kaiser & Kühne Freizeitgeräte GmbH

Im Südloh 5 – D-27324 Eystrup – Telephone 0049/4254/93150 – Fax 0049/4254/931524 – E-Mail info@kaiser-kuehne-play.com

We recommend, in addition to our instructions for maintenance, to consider carefully the demands of EN 1176-7



0-33206-001 K&K Water spiral (2,50)

Recommendations
about regular maintenance

	1 x weekly	2 x monthly	1 x monthly	4 x yearly	2 x yearly	1 x yearly
<input checked="" type="checkbox"/> Check cleanliness of play- and safety area, take out alien elements	<input type="checkbox"/>	<input type="checkbox"/>	<input checked="" type="checkbox"/>	<input type="checkbox"/>	<input type="checkbox"/>	<input type="checkbox"/>
<input checked="" type="checkbox"/> Check stability of supports, tighten bolt-connections if necessary	<input type="checkbox"/>	<input type="checkbox"/>	<input type="checkbox"/>	<input type="checkbox"/>	<input checked="" type="checkbox"/>	<input type="checkbox"/>
<input checked="" type="checkbox"/> Check other component elements for wear and tight connections, tighten connections and replace defective elements if necessary	<input type="checkbox"/>	<input type="checkbox"/>	<input type="checkbox"/>	<input type="checkbox"/>	<input checked="" type="checkbox"/>	<input type="checkbox"/>
<input checked="" type="checkbox"/> Check bearings and/or joints for tight fixing and easy-running function, replace them if necessary	<input type="checkbox"/>	<input type="checkbox"/>	<input type="checkbox"/>	<input type="checkbox"/>	<input checked="" type="checkbox"/>	<input type="checkbox"/>
<input checked="" type="checkbox"/> Check foundation, foundation anchoring and whole construction for corrosion, repair or replace if necessary.	<input type="checkbox"/>	<input type="checkbox"/>	<input type="checkbox"/>	<input type="checkbox"/>	<input type="checkbox"/>	<input checked="" type="checkbox"/>
<input checked="" type="checkbox"/> Check function of lower swivel joint, check specification according to attached drawing, as soon as specification is met or exceeded please de-install water spiral and replace complete bearing unit.	<input type="checkbox"/>	<input type="checkbox"/>	<input type="checkbox"/>	<input type="checkbox"/>	<input checked="" type="checkbox"/>	<input type="checkbox"/>

Please note:

The mentioned maintenance intervals are a recommendation only. They have to be adjusted to the needs and circumstances of a certain playground (e.g. due to the frequency of use, social facilities and vandalism problems etc

Instructions for maintenance

© 2008 Kaiser & Kühne Freizeitgeräte GmbH

Im Südloh 5 – D-27324 Eystrup – Telephone 0049/4254/93150 – Fax 0049/4254/931524 – E-Mail info@kaiser-kuehne-play.com

Specification to be checked on service interval 2x yearly

Factory setting 2-1,5 mm
Check minimum: 0,8 mm = Replacement

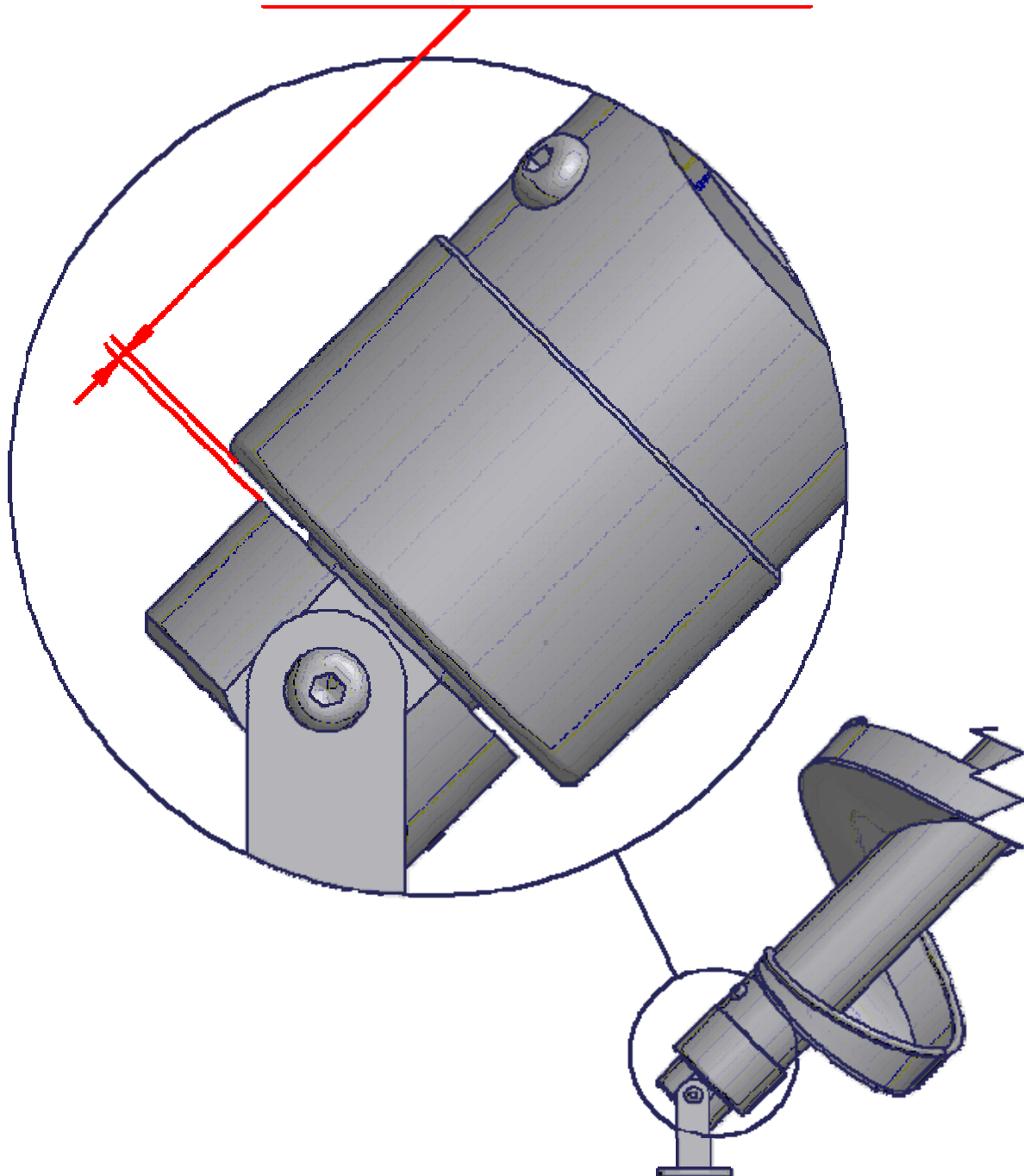

Measuring equipment:

drill of $\varnothing 0,8$ mm,
or other equipment, e.g. sliding calliper or feeler gauge