

# Instructions for maintenance

In addition to the manufacturer-related service instructions, we strongly advise the operator/owner to consider the corresponding prescriptions of the European Standard EN1176-7.



## 034330700 Water play structure













One-time maintenance

(exemplary colour illustration)



Check all screw connections; retighten, if necessary. Cover the screws with protective screw caps.

once, approx. 4-5 weeks after installation

Recommended regular inspection and maintenance		once a week	twice per month	once a month	four times a year	twice a year	once a year
	Where appropriate, clean playing sand	<input type="checkbox"/>	<input checked="" type="checkbox"/>	<input type="checkbox"/>	<input type="checkbox"/>	<input type="checkbox"/>	<input type="checkbox"/>
	Check cleanliness of playing and safety area. Remove any foreign object	<input type="checkbox"/>	<input type="checkbox"/>	<input checked="" type="checkbox"/>	<input type="checkbox"/>	<input type="checkbox"/>	<input type="checkbox"/>
	Check rubber parts like seats, hoses, flaps, collars for wear, replace if necessary	<input type="checkbox"/>	<input type="checkbox"/>	<input checked="" type="checkbox"/>	<input type="checkbox"/>	<input type="checkbox"/>	<input type="checkbox"/>
	In case of drying cracks, remove splinters of wood and chamfer sharp edges	<input type="checkbox"/>	<input type="checkbox"/>	<input checked="" type="checkbox"/>	<input type="checkbox"/>	<input type="checkbox"/>	<input type="checkbox"/>
	Where appropriate, check synthetic surfacing material for damages or severe wear, repair or replace, if necessary	<input type="checkbox"/>	<input type="checkbox"/>	<input checked="" type="checkbox"/>	<input type="checkbox"/>	<input type="checkbox"/>	<input type="checkbox"/>
	Check duty cycle and operating noise of the bottom joint of the screw pump; verify clearance dimension (see subsequent drawing); with deviation, dismount the screw pump and exchange the entire unit (both bearings and the sealing).	<input type="checkbox"/>	<input type="checkbox"/>	<input checked="" type="checkbox"/>	<input type="checkbox"/>	<input type="checkbox"/>	<input type="checkbox"/>
	If existing: The valve combination must not be located in water, thus: after rainfalls for instance, check the shaft for a water increase or check, if the valve combination is located in water.	<input type="checkbox"/>	<input type="checkbox"/>	<input type="checkbox"/>	<input checked="" type="checkbox"/>	<input type="checkbox"/>	<input type="checkbox"/>
	If existing: Check tightness and proper function of the valve combination: smoothly running pumping process, automatic closing process after pumping	<input type="checkbox"/>	<input type="checkbox"/>	<input type="checkbox"/>	<input checked="" type="checkbox"/>	<input type="checkbox"/>	<input type="checkbox"/>
	Check tightness of stand construction: stability of (vertical) posts or supports, retighten screw connections, if necessary.	<input type="checkbox"/>	<input type="checkbox"/>	<input type="checkbox"/>	<input type="checkbox"/>	<input checked="" type="checkbox"/>	<input type="checkbox"/>
	Check further structural components for wear and tightness; retighten, if necessary and replace defective parts.	<input type="checkbox"/>	<input type="checkbox"/>	<input type="checkbox"/>	<input type="checkbox"/>	<input checked="" type="checkbox"/>	<input type="checkbox"/>
	Check bearings and/or joints for tight fixing and easy-running function, replace or grease, if necessary (water pump handle, hand wheel at the upper end of the screw pump).	<input type="checkbox"/>	<input type="checkbox"/>	<input type="checkbox"/>	<input type="checkbox"/>	<input checked="" type="checkbox"/>	<input type="checkbox"/>
	Check tightness/stability of the connection between stainless steel support and laminated timber post, replace post, if necessary.	<input type="checkbox"/>	<input type="checkbox"/>	<input type="checkbox"/>	<input type="checkbox"/>	<input checked="" type="checkbox"/>	<input type="checkbox"/>
	Check foundations and structural construction for corrosion or decay, repair or replace if necessary	<input type="checkbox"/>	<input type="checkbox"/>	<input type="checkbox"/>	<input type="checkbox"/>	<input type="checkbox"/>	<input checked="" type="checkbox"/>

# Instructions for maintenance

Please note: The above-mentioned maintenance intervals only have recommendatory character. They must necessarily be adapted to the local circumstances of each playground (frequency of use, social setting, risk and frequency of vandalism etc.).

**Attention:**

Concerning additional specifications for water pump maintenance or for additional valve combinations, see separate instructions for each unit.

**Factory default 2-1,5 mm**

**Minimum reference dimension 0,8 mm = replacement**

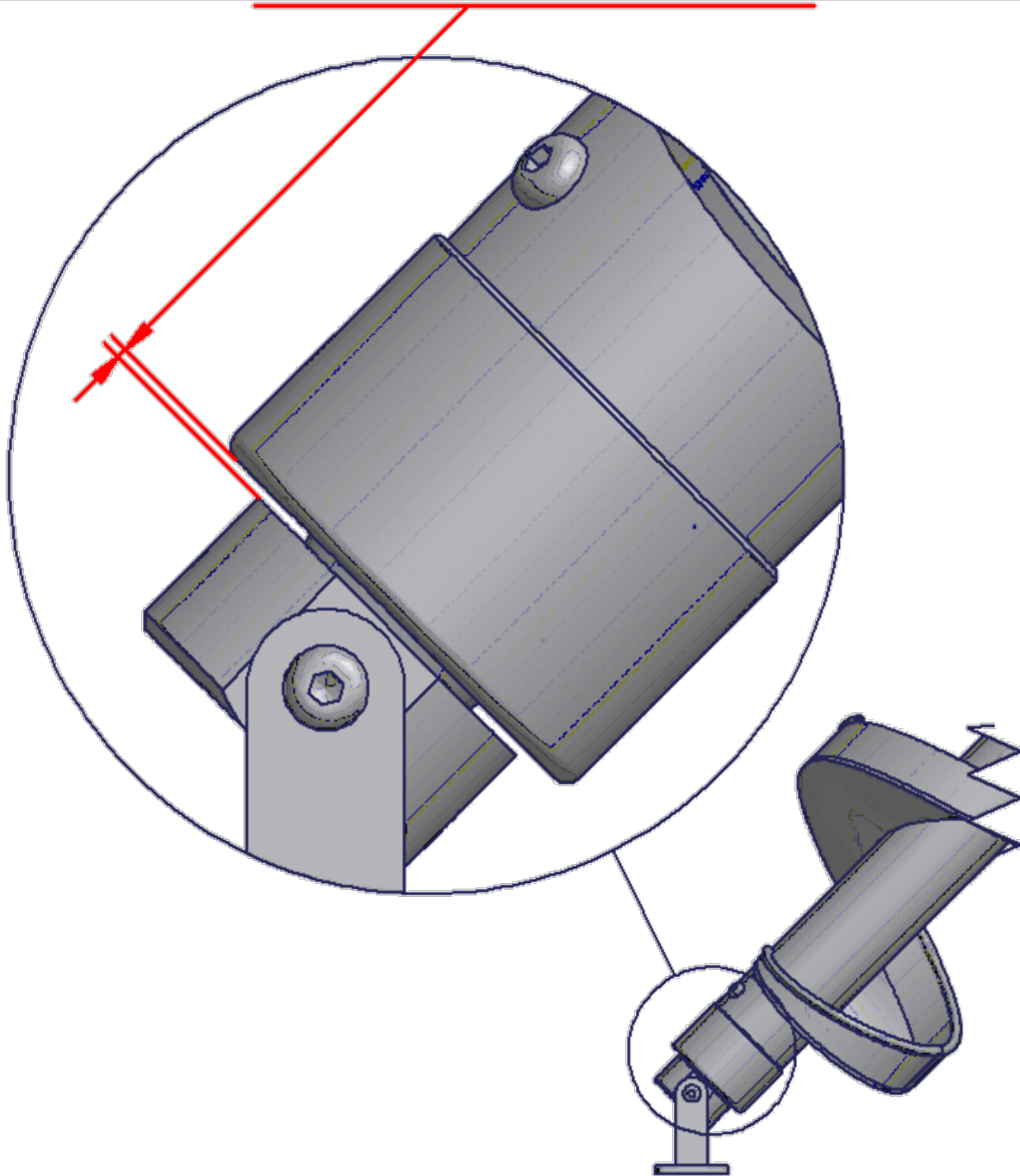

Appropriate measuring tools:

- Drill bit Ø 0,8 mm or
- Calliper gauges or
- Feeler gauges