

Instructions for maintenance

In addition to the manufacturer-related service instructions, we strongly advise the operator/owner to consider the corresponding prescriptions of the European Standard EN1176-7.



034370500 Water play structure











One-time maintenance

(exemplary colour illustration)



Check all screw connections; retighten, if necessary.

once, approx. 4-5 weeks after installation

| Recommended regular inspection and maintenance | | once a week | twice per month | once a month | four times a year | twice a year | once a year |
|---|--|--------------------------|--------------------------|-------------------------------------|-------------------------------------|-------------------------------------|-------------------------------------|
|  | Check cleanliness of playing and safety area. Remove any foreign object | <input type="checkbox"/> | <input type="checkbox"/> | <input checked="" type="checkbox"/> | <input type="checkbox"/> | <input type="checkbox"/> | <input type="checkbox"/> |
|  | Check rubber parts like seats, hoses, flaps, collars for wear, replace if necessary | <input type="checkbox"/> | <input type="checkbox"/> | <input checked="" type="checkbox"/> | <input type="checkbox"/> | <input type="checkbox"/> | <input type="checkbox"/> |
|  | In case of drying cracks, remove splinters of wood and chamfer sharp edges | <input type="checkbox"/> | <input type="checkbox"/> | <input checked="" type="checkbox"/> | <input type="checkbox"/> | <input type="checkbox"/> | <input type="checkbox"/> |
|  | Where appropriate, check synthetic surfacing material for damages or severe wear, repair or replace, if necessary | <input type="checkbox"/> | <input type="checkbox"/> | <input checked="" type="checkbox"/> | <input type="checkbox"/> | <input type="checkbox"/> | <input type="checkbox"/> |
|  | Check duty cycle and operating noise of the bottom joint of the screw pump; verify clearance dimension (see subsequent drawing); with deviation, dismount the screw pump and exchange the entire unit (both bearings and the sealing). | <input type="checkbox"/> | <input type="checkbox"/> | <input checked="" type="checkbox"/> | <input type="checkbox"/> | <input type="checkbox"/> | <input type="checkbox"/> |
|  | The valve combination must not be located in water, thus: after rainfalls for instance, check the shaft for a water increase or check, if the valve combination is located in water. | <input type="checkbox"/> | <input type="checkbox"/> | <input type="checkbox"/> | <input checked="" type="checkbox"/> | <input type="checkbox"/> | <input type="checkbox"/> |
|  | Check tightness and proper function of the valve combination: smoothly running pumping process, automatic closing process after pumping | <input type="checkbox"/> | <input type="checkbox"/> | <input type="checkbox"/> | <input checked="" type="checkbox"/> | <input type="checkbox"/> | <input type="checkbox"/> |
|  | Check tightness of stand construction: stability of (vertical) posts or supports, retighten screw connections, if necessary. | <input type="checkbox"/> | <input type="checkbox"/> | <input type="checkbox"/> | <input type="checkbox"/> | <input checked="" type="checkbox"/> | <input type="checkbox"/> |
|  | Check further structural components for wear and tightness; retighten, if necessary and replace defective parts. | <input type="checkbox"/> | <input type="checkbox"/> | <input type="checkbox"/> | <input type="checkbox"/> | <input checked="" type="checkbox"/> | <input type="checkbox"/> |
|  | Check bearings and/or joints for tight fixing and easy-running function, replace or grease, if necessary (water pump handle, hand wheel at the upper end of the screw pump). | <input type="checkbox"/> | <input type="checkbox"/> | <input type="checkbox"/> | <input type="checkbox"/> | <input checked="" type="checkbox"/> | <input type="checkbox"/> |
|  | Check foundations and structural construction for corrosion or decay, repair or replace if necessary | <input type="checkbox"/> | <input type="checkbox"/> | <input type="checkbox"/> | <input type="checkbox"/> | <input type="checkbox"/> | <input checked="" type="checkbox"/> |

Please note: The above-mentioned maintenance intervals only have recommendatory character. They must necessarily be adapted to the local circumstances of each playground (frequency of use, social setting, risk and frequency of vandalism etc.).

Instructions for maintenance

Attention:

Concerning additional specifications for water pump maintenance or for additional valve combinations, see separate instructions for each unit.

Factory default 2-1,5 mm

Minimum reference dimension 0,8 mm = replacement

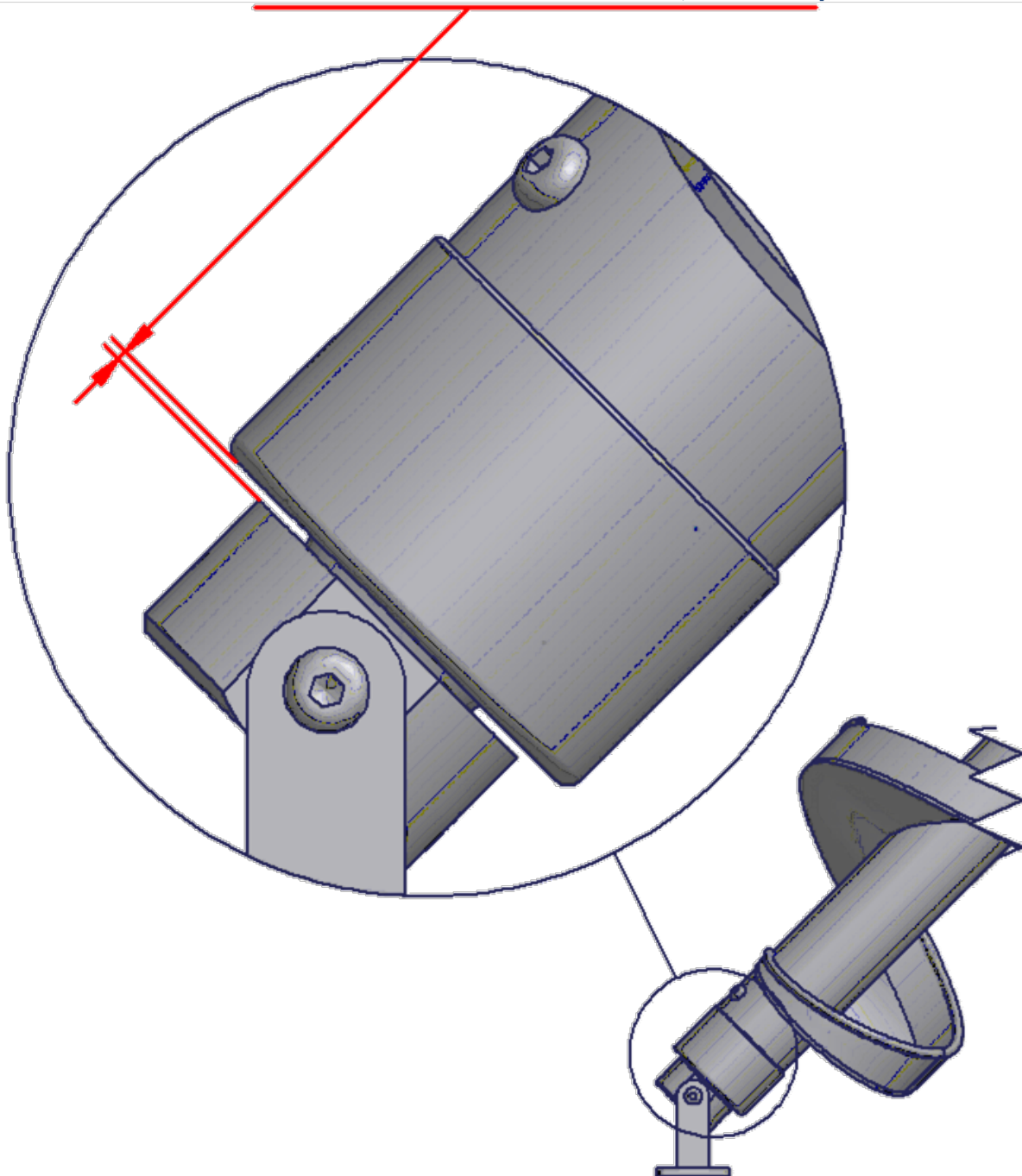

Appropriate measuring tools:

- Drill bit \varnothing 0,8 mm or
- Calliper gauges or
- Feeler gauges