

(exemplary colour illustration)

Item

**057038000**

**Safety and stretching rail**

Mounting instructions

1. for installation as *permanently installed public **playground equipment*** according to **EN 1176** (Pages: 1-2)
2. for installation as *permanently installed outdoor **fitness equipment*** according to **EN 16630** (Pages: 3-4)



The delivered product is labelled with a round sticker stating the standard intended for use (EN 16630 or EN 1176).



# Mounting instructions for installation as permanently installed public **playground equipment** according to **EN 1176**

www.kaiser-kuehne.com T. +49 (0) 42 54 / 93 15-0

© Kaiser & Kühne Freizeitgeräte D-27324 Eystrup

Installation

4x safety screw M12x25-A2

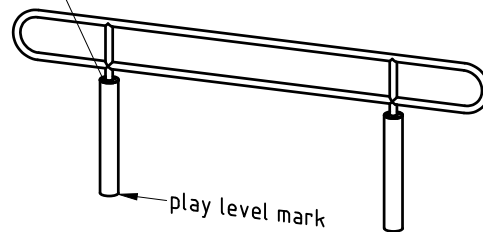

1. Assign a location for the equipment considering the space requirement (impact area) .
2. Excavate soil for foundations, according to drawing.  
Please note: To achieve maximum stability and a safe installation, a moderate level of soil solubility is required.
3. Pour in a drain layer of gravel of approx. 10 cm thickness between the bottom of the posts and plain base of foundation.
4. Put posts into the respective hole of foundation. Play level mark (welded pin) complies with the orientation and mounting depth of the posts.
5. **Attention: For installation of the pre-assembled components and/or single parts, the screws slightly have to be lubricated with installation paste! Tighten all screws after having aligned all components.**
6. Grout foundations with compressed concrete C20/25, chamfer and round off the edges. The soil characteristics of the area surrounding the equipment must have an appropriate level of shock absorption corresponding to the free height of fall (according to EN 1176-1).
7. Release for play after concrete foundations have set.
8. Check all screw connections according to maintenance instructions after 4-5 weeks and screw down again if necessary.

detail of check mark  
1:5

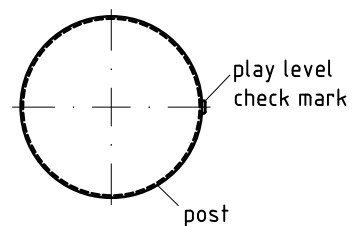

Please take care that all special tools (e.g. special Allen key for secured Allen screws etc.) and all specific documents which are or may be useful for safety management acc. to EN 1176-7 (e.g. invoice, delivery note, order acknowledgement, installation instructions, maintenance instructions) are forwarded to the responsible persons.

# Mounting instructions for installation as permanently installed public **playground equipment** according to **EN 1176**

www.kaiser-kuehne.com T. +49 (0) 42 54 / 93 15-0

© Kaiser & Kühne Freizeitgeräte D-27324 Eystrup

Installation

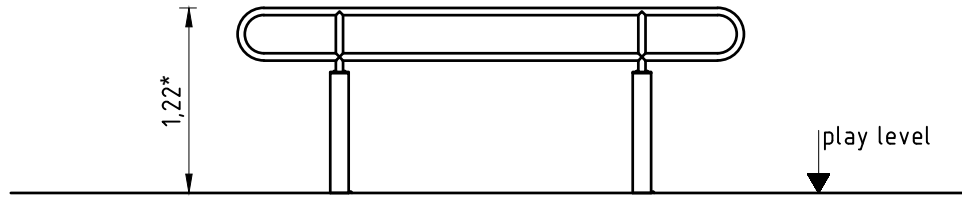

\*max. free height of fall

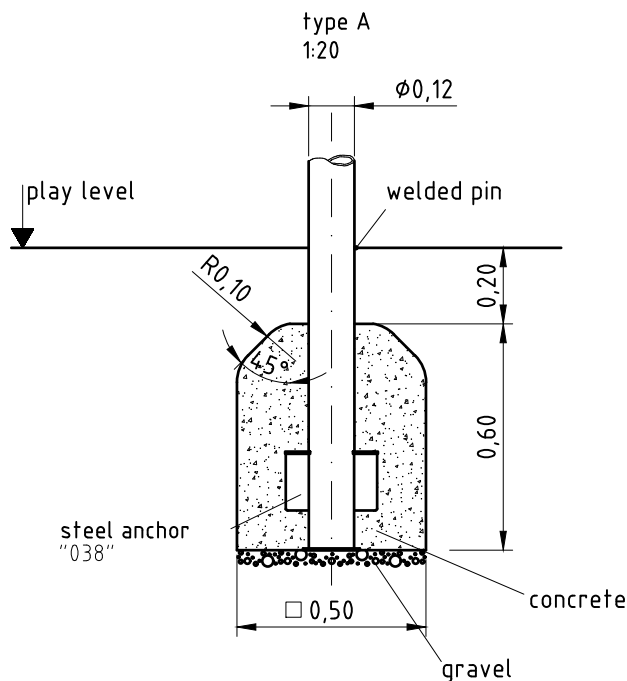
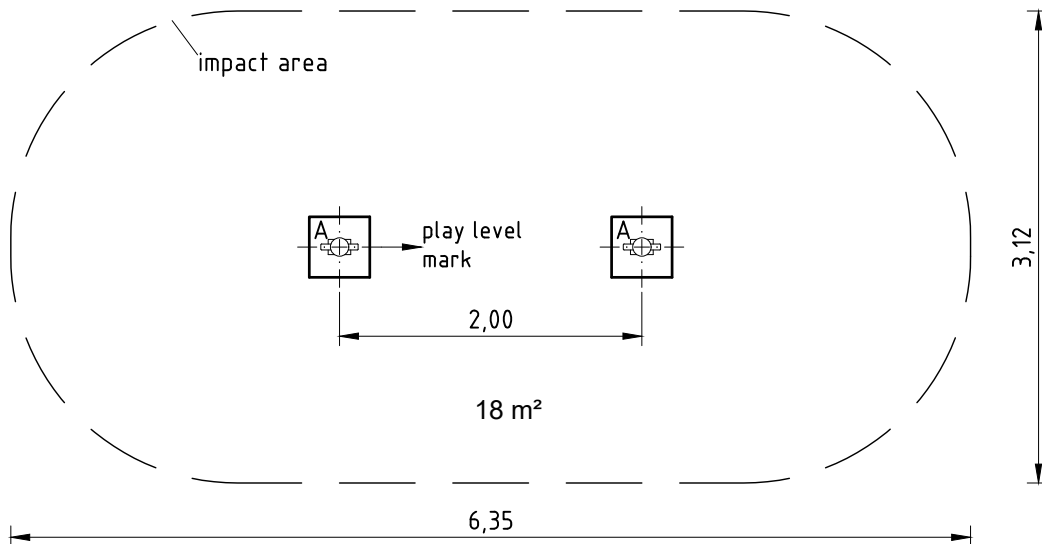

# Mounting instructions for installation as permanently installed outdoor **fitness equipment** according to **EN 16630**

www.kaiser-kuehne.com T +49 42 54 / 93 15-0

© Kaiser & Kühne Freizeitgeräte D-27324 Eystrup

Installation

4x safety screw M12x25-A2

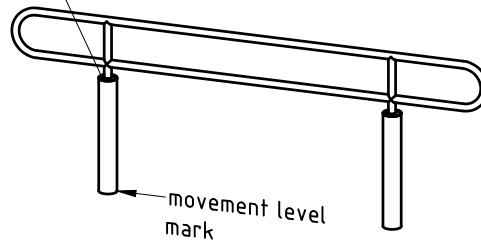

1. Assign a location for the equipment considering the space requirement (movement area).
2. Excavate soil for foundations, according to drawing.  
Please note: To achieve maximum stability and a safe installation, a moderate level of soil solubility is required.
3. Pour in a drain layer of gravel of approx. 10 cm thickness between the bottom of the posts and plain base of foundation.
4. Put posts into the respective hole of foundation. Movement level mark (welded pin) complies with the orientation and mounting depth of the posts.
5. **Attention: For installation of the pre-assembled components and/or single parts, the screws slightly have to be lubricated with installation paste! Tighten all screws after having aligned all components.**
6. Grout foundations with compressed concrete C20/25, chamfer and round off the edges. The soil characteristics of the area surrounding the equipment must have an appropriate level of shock absorption corresponding to the free height of fall (according to EN 16630).
7. Release for play after concrete foundations have set.
8. Check all screw connections according to maintenance instructions after 4-5 weeks and screw down again if necessary.

detail of check mark  
1:5

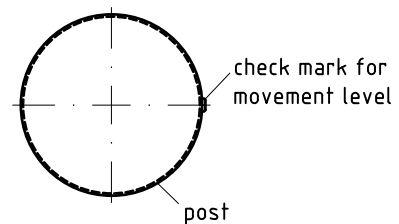

Please take care that all special tools (e.g. special Allen key for secured Allen screws etc.) and all specific documents which are or may be useful for a safety management (e.g. invoice, delivery note, order acknowledgement, installation instructions, maintenance instructions) are forwarded to the responsible persons.

# Mounting instructions for installation as permanently installed outdoor **fitness equipment** according to **EN 16630**

www.kaiser-kuehne.com T +49 42 54 / 93 15-0

© Kaiser & Kühne Freizeitgeräte D-27324 Eystrup

Installation

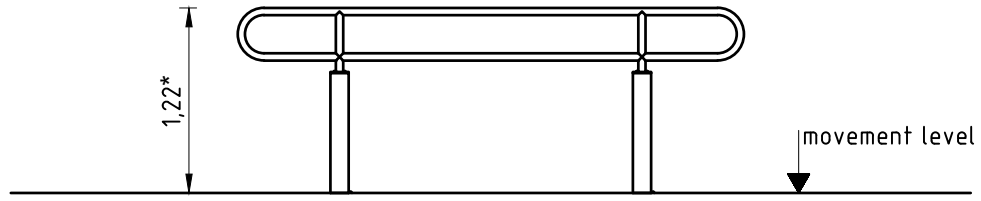

\*max. free height of fall

