



# Kaiser & Kühne

## INSTALLATION

0-56663-000

Climbing Rock Midi

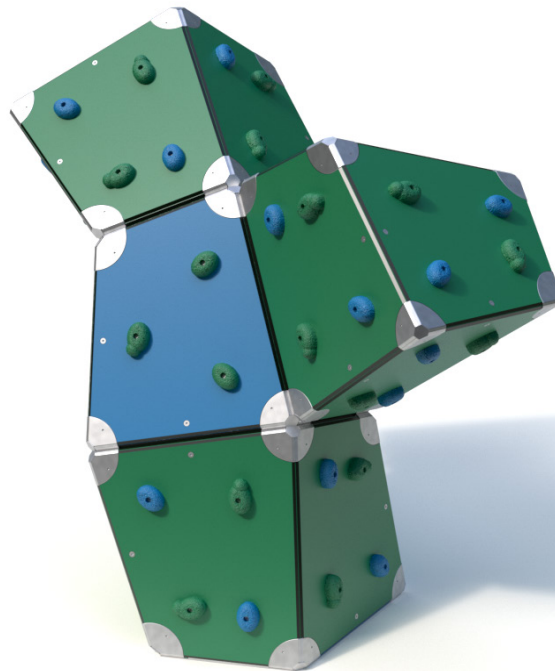

### Werkzeuge / tools

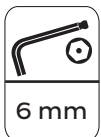

Kaiser & Kühne

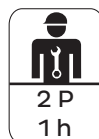

Kunde / customer

**DE**

1. Gerätestandort unter Berücksichtigung des Platzbedarfs (Aufprallfläche) festlegen.
2. Bodenaushub für das Fundament nach Zeichnung vornehmen. Bitte beachten Sie: Für eine standsichere Montage werden mittel-schwer lösbare Bodenarten vorausgesetzt.
3. Ca. 10 cm dicke Schicht Grobkies als Drainageschicht zwischen Unterseite des Fundamentankers und der Fundamentsohle einbringen.
4. Fundamentanker und Betonstahlmatten im Fundamentloch platzieren. Anker z.B. mit einer Wasserwaage ausrichten, ggf. abstützen.
5. Fundamentanker wie in der Detailansicht dargestellt mit Stampfbeton C20/25 füllen.
6. Weitere Montage erst nach Abbinden der Betonfundamente.
7. Freigabe zum Bespielen erst nach Erstellung eines normgerechten Spielplatzbodens.
8. Alle Schraubverbindungen gemäß Wartungsanleitung nach 4-5 Wochen überprüfen und ggf. fest nachziehen.

Alle mit dem Gerät gelieferten Spezialwerkzeuge (z.B. Innensechskant- Schlüssel für gesicherte Schrauben etc.) sowie alle gerätespezifischen Unterlagen, die für das Sicherheitsmanagement nach EN 1176-7 wichtig sind oder sein könnten wie z.B. Rechnung, Lieferschein oder Auftragsbestätigung, Montageanleitung und Wartungsanleitung im Original oder in einer Kopie an die zuständigen Stellen weiterleiten.

**Bitte beachten Sie:**

Um einen sicheren und unfallfreien Spielbetrieb an diesem Gerät zu gewährleisten, müssen die im Wartungsplan aufgeführten Tätigkeiten unbedingt ausgeführt werden.

**GB**

1. Assign a device location considering the space requirements (impact area).
2. Excavate soil for the foundation, according to drawing. Please note: To achieve maximum stability and a safe installation, a moderate level of soil solubility is required.
3. Pour in a drain layer of gravel of approx. 10 cm thickness between the bottom of the foundation frame and plain base of foundation.
4. Place frame and welded wire mesh into the foundation hole. Align the frame by means of a spirit level, support the entire unit, if necessary.
5. Grout foundation with compressed concrete C20/25, as illustrated in the detailed front view.
6. Further assembly not before concrete has set.
7. Release for play after installation of appropriate playground surfacing.
8. According to maintenance instructions, check all screw connections after 4-5 weeks and retighten, if necessary.

Please ensure that all special tools supplied (e.g. Allen key for secured Allen screws etc.) and all specific documents which are or may be useful for safety management acc. to EN 1176-7 (e.g. invoice, delivery note, order acknowledgement, installation instructions, maintenance instructions) are forwarded to the persons responsible.

**Please note:**

For safe playing circumstances without accidents, it is essential to execute the scale of operations listed in the maintenance schedule.

**Geräteraum  
space occupied by  
equipment**

2,39 x 1,77 x 2,40 m

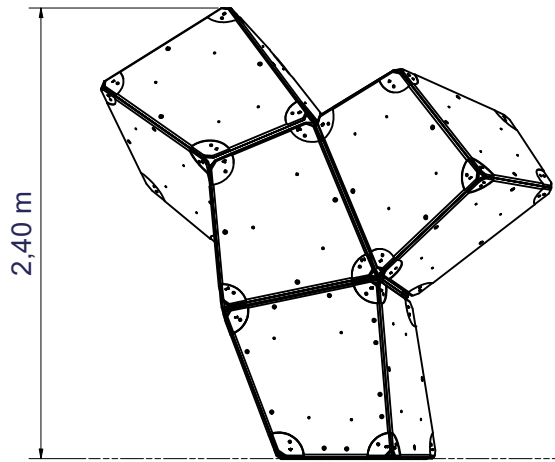
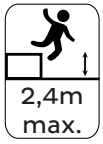

**Mindestraum  
minimum space**

5,67 x 5,13 x 2,40 m

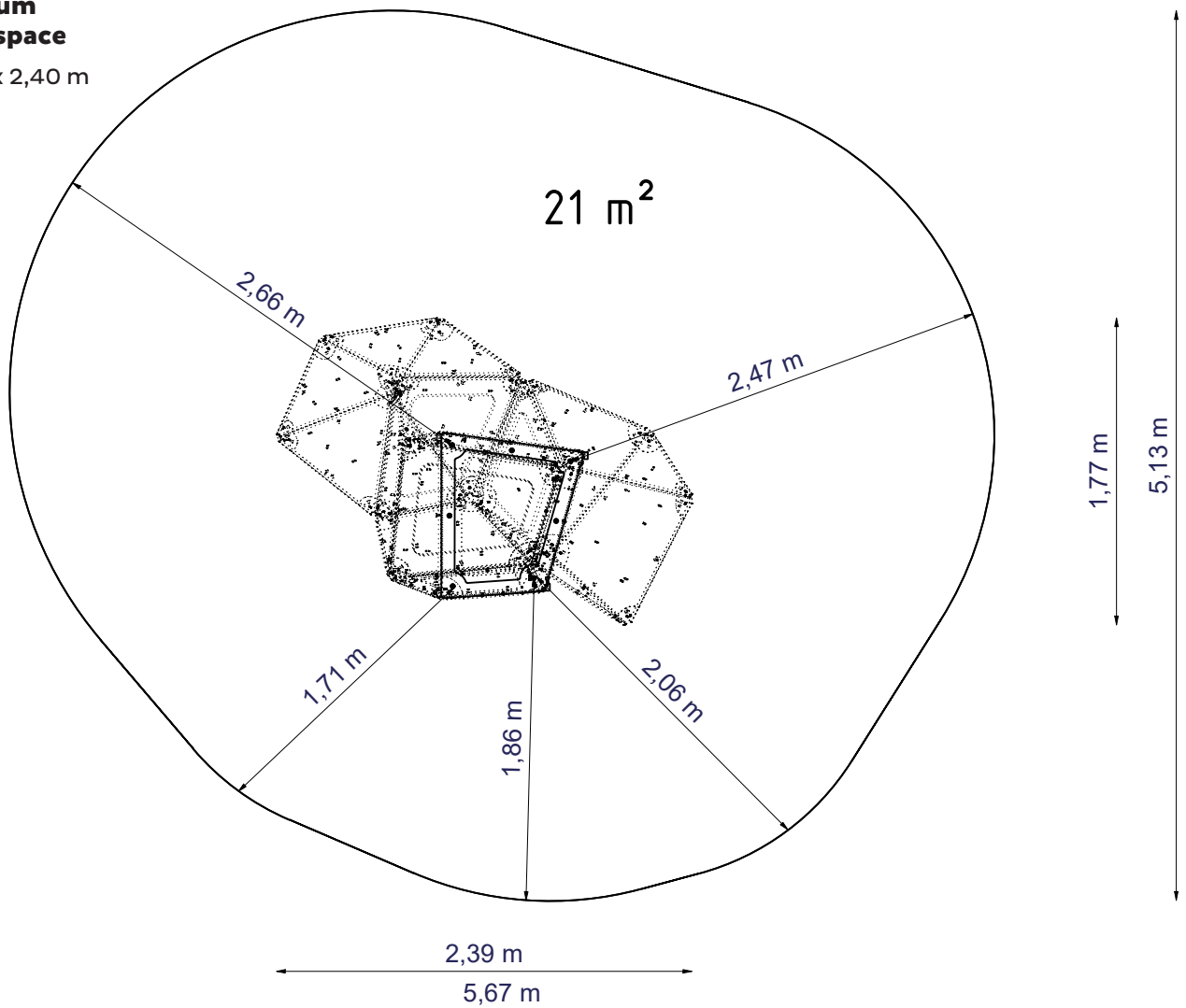

**Fundamentplan  
foundation plan**





Fundamente (bauseits)  
Foundations (on site)

Betonbedarf (ca.)  
Concrete amount (approx.)

A- 1x 0,95 x 0,83 x 0,45 m  
B- 1x 1,46 x 1,33 x 0,35 m

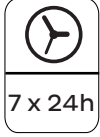
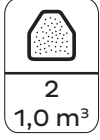
1,0 m<sup>3</sup>



  
**ATTENTION**

Die Montage des Climbing Rock Midi erfolgt erst **nach** Abbinden des Betonfundamentes.



The assembly of the Climbing Rock Midi only takes places **after** concrete foundations have set.

Spielebene  
playing surface

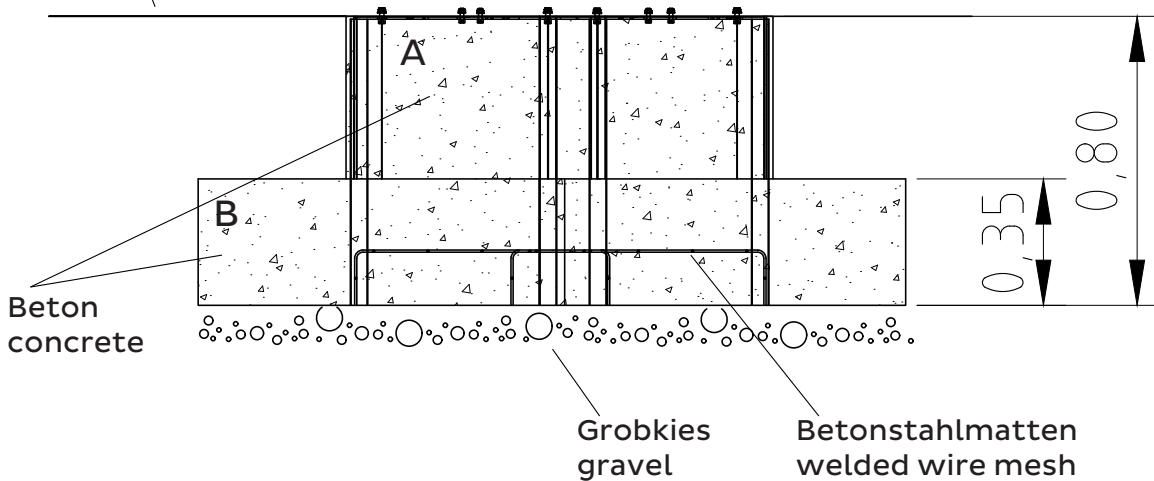

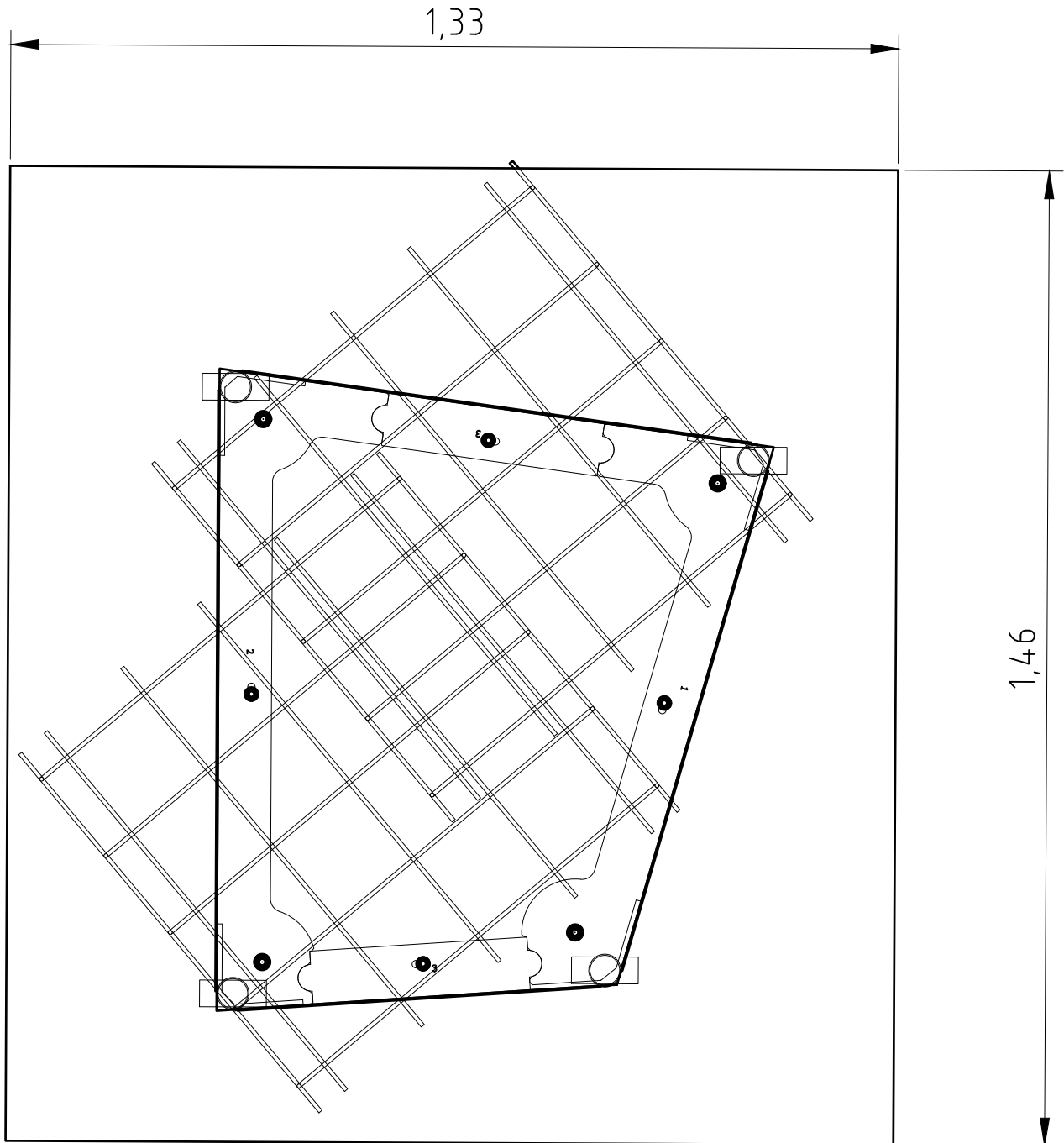

**Komponenten  
components**

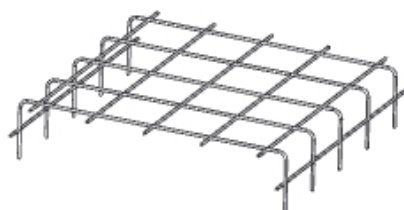

2130051  
2x

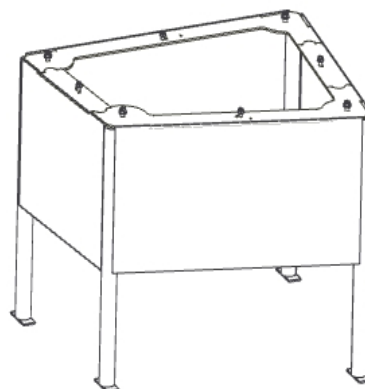

110320  
1x

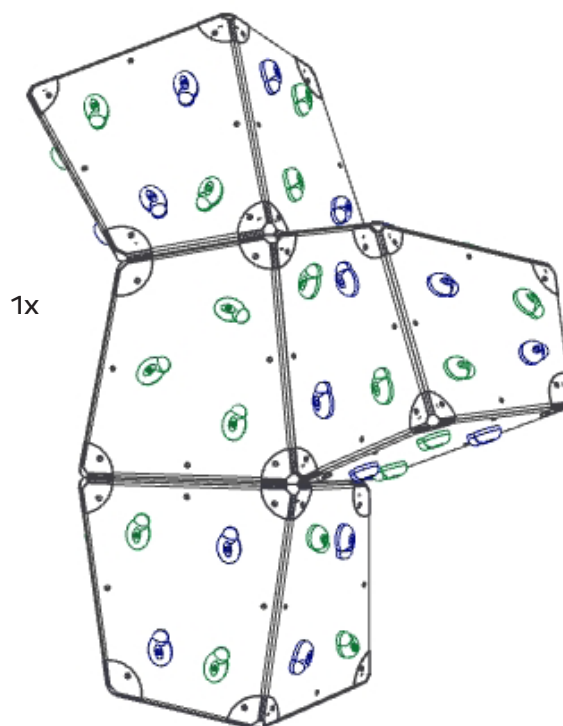

1x

**Step**  
**1**

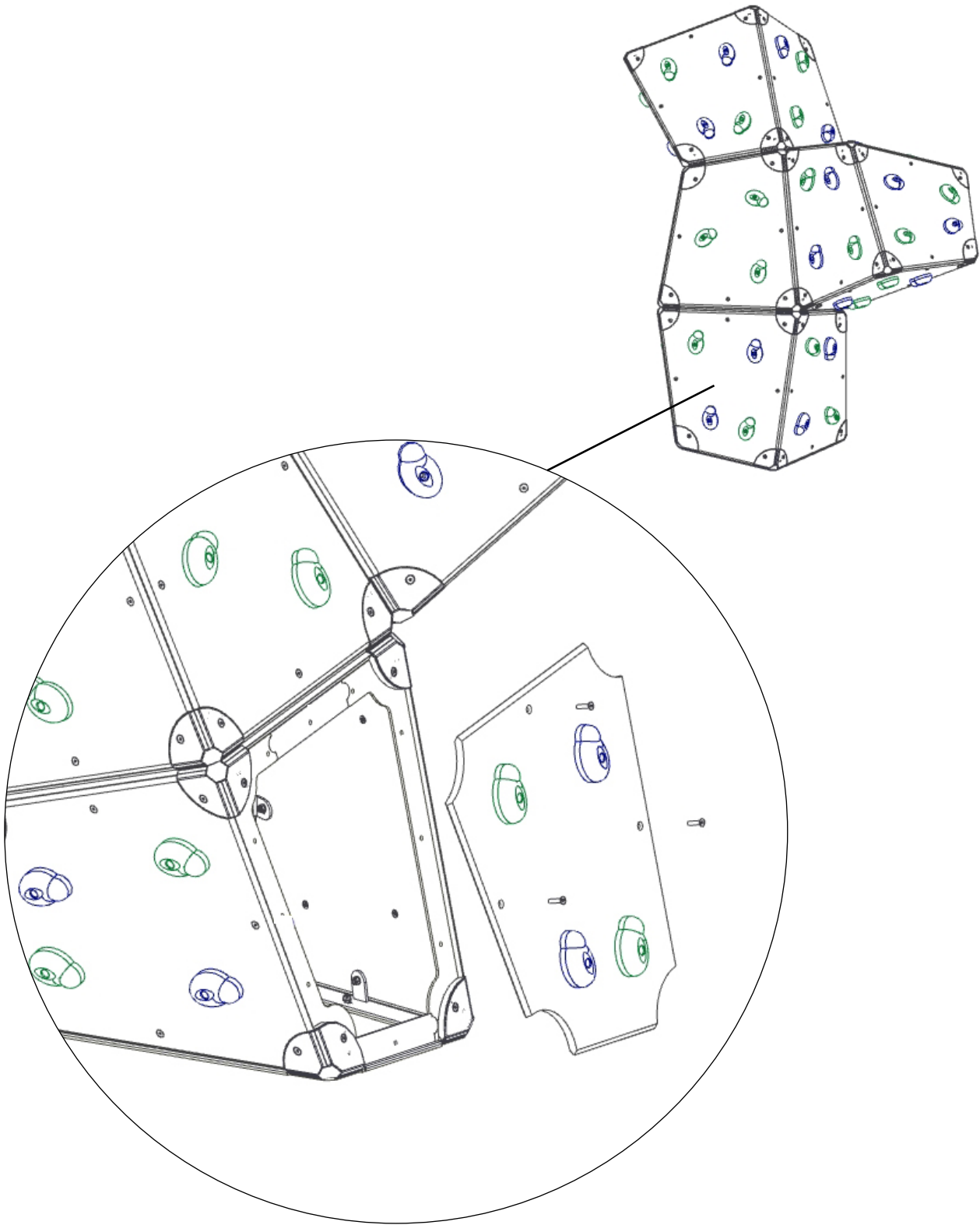
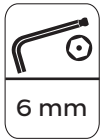

**Step  
2**



17 mm



19 mm

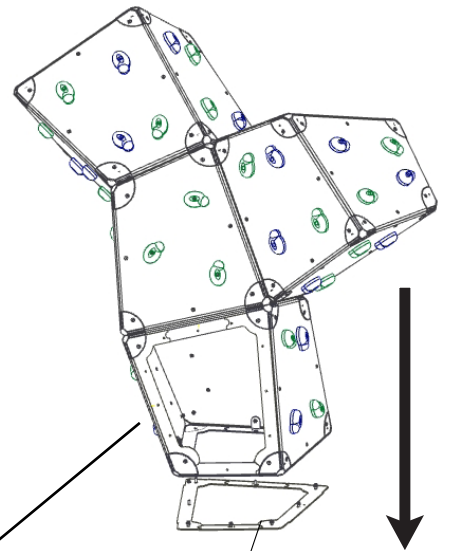

Fundamentrahmen  
foundation frame

