

1. Assign a device location considering the space requirements (impact area).
2. Excavate soil for foundations, according to drawing.  
Please note: To achieve maximum stability and a safe installation, a moderate level of soil solubility is required.
3. Pour in a drain layer of gravel of approx. 10 cm thickness between the bottom of the posts and plain base of foundation.
4. Insert reinforcing steel into the corresponding holes of the posts.
5. Place posts type A according to the corresponding number (see foundation layout) into the respective foundation hole. Play level mark (=aluminium blind rivet) complies with the installation depth. Align every post by means of the play level mark facing into the same direction (see detail or foundation layout).
- 6. For installation of the pre-assembled components and/or single parts, the screws slightly have to be lubricated with installation paste!**  
**Tighten all screws after having aligned all components.**  
Screw connections see details in attached list.
7. Grout foundations with compressed concrete C20/25, chamfer and round off the edges, cover the foundations with a surface which meets the requirements for impact attenuation so that the critical fall height of the surfacing is equal to, or greater than, the free height of fall of the equipment (acc. to EN 1176-1).
8. Release for play after concrete foundations have set.
9. According to maintenance instructions, check all screw connections after 4-5 weeks and retighten, if necessary.

Please ensure that all special tools supplied (e.g. Allen key for secured Allen screws etc.) and all specific documents which are or may be useful for safety management acc. to EN 1176-7 (e.g. invoice, delivery note, order acknowledgement, installation instructions, maintenance instructions) are forwarded to the persons responsible.

**Necessarily insert all attachment parts before tightening the screws. It is NOT possible to insert them afterwards.**

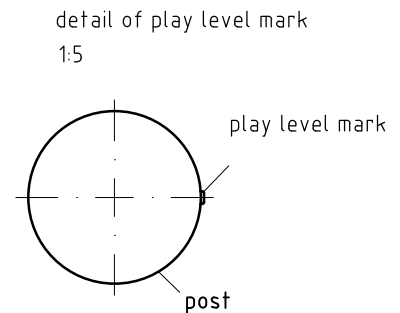
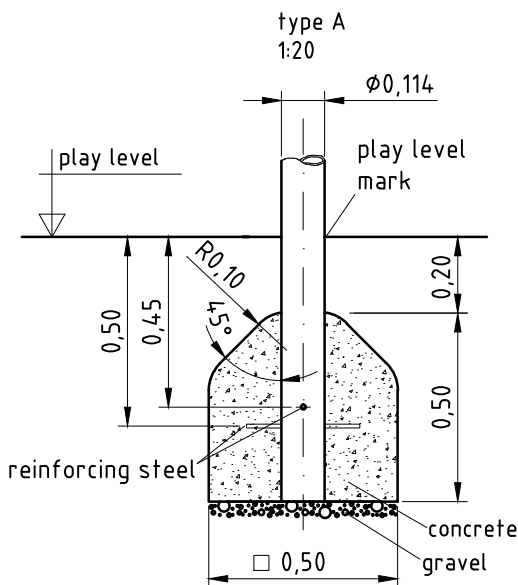
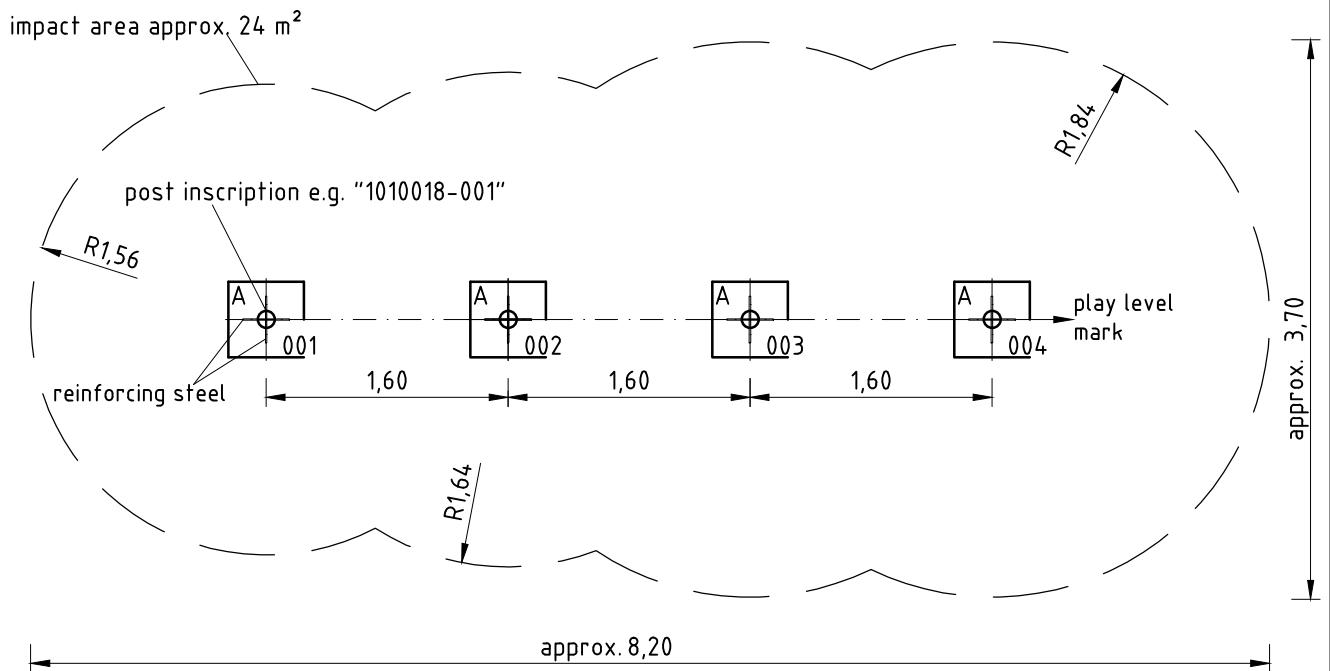
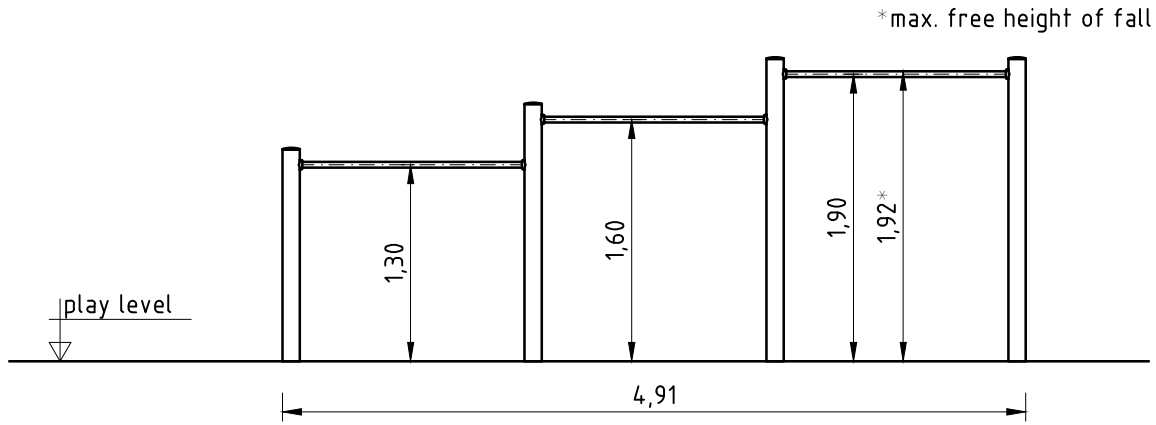

Item: **0-53125-900**

Order:

1299500

K&K Triple chin-up bars (1,30/1,60/1,90)

Location:

Building Project:

**6 x SFES1210001 Standard bolting of add-on pieces for fastening of ES120 add-on pieces at steel posts (except platforms)**

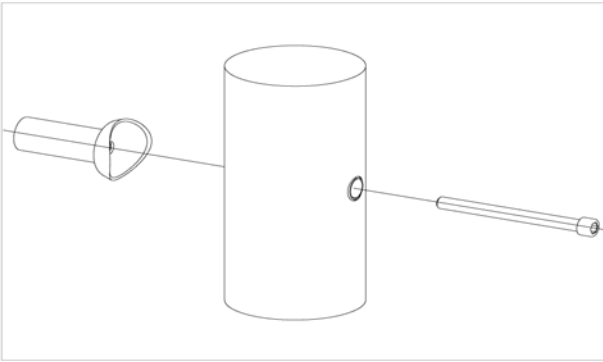

per SC	Total	K&K-Item	Marking
1 x	6 x	2030168	Cheese head screw M12x140 with pin for fastening of ES120-add-on pieces at steel posts (except platforms)

**4 x SFES1270001 Reinforcing steel for stainless steel posts**



per SC	Total	K&K-Item	Marking
2 x	8 x	2130000	Reinforcing steel Ø 10 x 310 DIN 488

**1 x SFWZ0000009 Hexagon insert socket driver 10mm 1/2" with borehole for Pin**



per SC	Total	K&K-Item	Marking
1 x	1 x	2030170	Hexagon insert socket driver 10 mm 1/2" with drill hole for Pin

**1 x SFWZ0000014 Lubricating metal, bag (4g)**



per SC	Total	K&K-Item	Marking
1 x	1 x	5300024	Metaflux fitting lubricant 2x4 gr.