

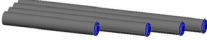











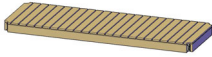
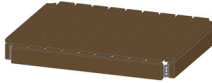



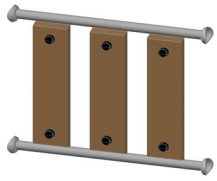
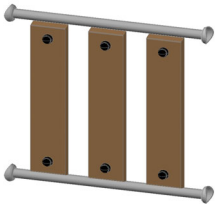

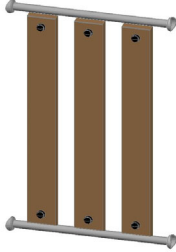

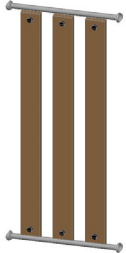

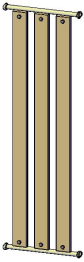



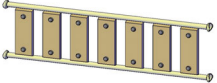
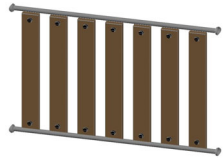

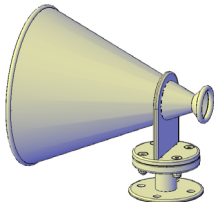
<u>Parts list</u>		022712504	GB
item no.	quantity	description	image
1273388	1	set of stainless steel posts for 022712504	
6290032	35	stainless steel post cap / blue RAL 5015	
1200000	11	square platform 0,80 m x 0,80 m	
1200001	4	rectangular platform 0,80 m x 1,60 m	
1200002	1	rectangular platform 0,80 m x 2,40 m	
1200016	1	rectangular platform 0,80 m x 1,01 m	



<u>Parts list</u>		022712504	GB
item no.	quantity	description	image
1200006	1	hexagonal platform 6 x 0,80	 A hexagonal platform made of wooden slats, shown from a top-down perspective.
1210358	1	bowed guardrail 0,80 m	 A single, curved metal guardrail with rounded ends.
1210022	5	tandem guardrail 0,80 m	 A tandem guardrail consisting of two parallel metal rails connected by a central crossbar.
1210023	3	tandem guardrail 1,60 m	 A tandem guardrail consisting of two parallel metal rails connected by a central crossbar, shown at an angle.
1210176	1	timber balustrade 0,80 m x 0,50 m	 A timber balustrade with two horizontal metal rails and three vertical wooden posts.
1210010	3	timber infill barrier 0,80 m x 0,60 m	 A timber infill barrier with two horizontal metal rails and three vertical wooden posts, shown at an angle.

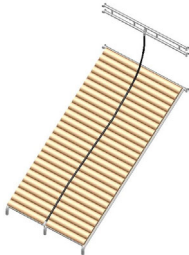

<u>Parts list</u>		022712504	GB
item no.	quantity	description	image
1210198	1	timber infill barrier 0,80 m x 0,70 m	
1210011	3	timber infill barrier 0,80 m x 0,80 m	
1210012	1	timber balustrade 0,80 m x 1,00 m	
1210087	1	timber infill barrier 0,80 m x 1,15 m	
1210088	1	timber balustrade 0,80 m x 1,55 m	
1210017	1	timber balustrade 0,80 m x 2,00 m	

<u>Parts list</u>		022712504	GB
item no.	quantity	description	image
1210072	3	timber infill barrier 0,80 m x 2,40 m	
1210073	1	timber infill barrier 0,80 m x 2,60 m	
1210074	6	timber balustrade 0,80 m x 2,80 m	
1210075	1	timber balustrade 1,014 m x 1,20 m	
1210076	1	timber balustrade 1,014 m x 2,40 m	
1210077	1	timber infill barrier 1,60 m x 0,40 m	

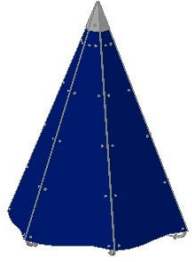
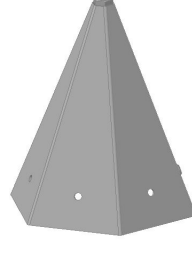
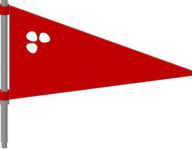
<u>Parts list</u>		022712504	GB
item no.	quantity	description	image
1210239	1	balustrade en bois 1,60 m x 0,95 m	
1210238	1	balustrade en bois 1,60 m x 1,35 m	
1210079	2	balustrade en bois 2,40 m x 0,70/0,10 m	
1260128	1	megaphone for post cap attachment	
1210359	1	horizontal bar/ladder rung 0,80 m	
1210032	2	cranked ladder rung 0,80 m	

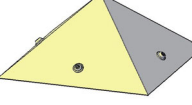
<u>Parts list</u>		022712504	GB
item no.	quantity	description	image
1220012	2	bench seat type 1 / 0,80 m / red HPL	
1220013	1	bench seat type 3 / 0,80 m / red HPL	
1220002	1	semi-circular counter/ seat 0,80 m / red HPL	
1230051	1	vertical climbing pole 2,70 m / horizontal arch	
1230018	1	inclined ramp 1,60 m / platform height 1,80 m	
1230055	1	stairs 0,80 m platform height 0,80 m	

<u>Parts list</u>		022712504	GB
item no.	quantity	description	image
1210242	1	pair of infill barriers for stairs 0,80 m	
1240078	1	tower-shaped roof 72° / 6 x 0,80m / royal blue HPL	
6240031	1	hood for tower roof 72° with flag receptacle	
1240081	1	straight red flag/RAL 2002 incl. flag pole	
1240070	1	tent roof 45° / 4 x 0,80 m / blue HPL	
6240054	1	hood for tent roof 4 x 45°	

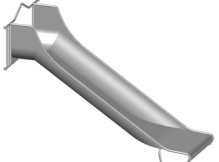
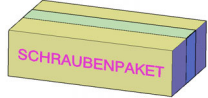
<u>Parts list</u>		022712504	GB
item no.	quantity	description	image
6230129	2	pair of chains for a drawbridge	
1230041	1	inclined ramp 1,60 m x 1,60 m x 0,40 m 12,5°	
041421001	1	K&K Trough-shaped attachment slide (2,00)	
041447001	1	K&K Wide attachment slide (1,40)	
1293747	1	fastening kit for 022712504	

Item: **022712504**
 K&K Play structure
 Location:

Order:

1293747

Building Project:

74 x SFES120001 Platform fastening to stainless steel post, nut on the side of the platform

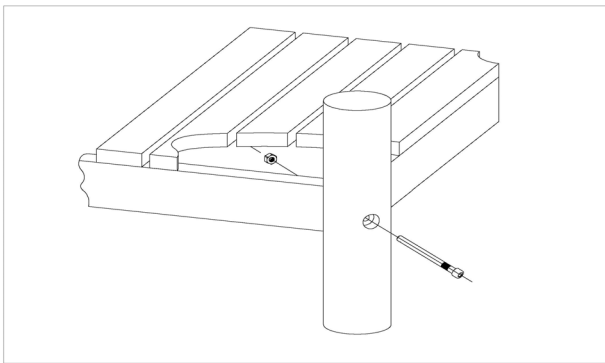

per SC	Total	K&K-Item	Marking
1 x	74 x	3430021	Lock nut M12 DIN985 A2
1 x	74 x	2030651	Cheese head screw with pin M12 x 125

212 x SFES1210001 Standard bolting of attachment parts (except platforms) to stainless steel posts

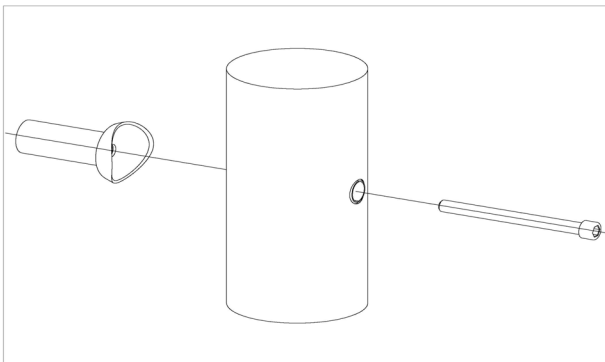

per SC	Total	K&K-Item	Marking
1 x	212 x	2030168	Cheese head screw with pin M12x140

2 x SFES1230001 Chain net or similar at stainless steel posts

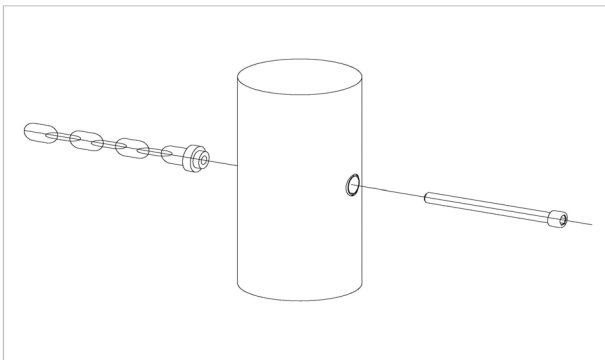

per SC	Total	K&K-Item	Marking
1 x	2 x	2030246	Cheese head screw M12 x 110 with pin

44 x SFAS1210002 Waling timber for parapet fastening to platforms

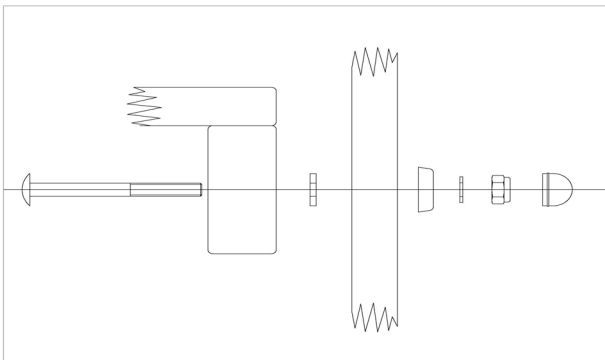

per SC	Total	K&K-Item	Marking
1 x	44 x	3300056	white protective screw cap - lower part, M10
1 x	44 x	3430014	Washer Ø 10,5 DIN125 form B A2
1 x	44 x	3430108	washer Ø 10,5 DIN 7349 A2
1 x	44 x	3430048	Lock nut M10 DIN985 A2
1 x	44 x	3300057	white protective screw cap - upper part, M10
1 x	44 x	3400651	Mushroom head screw M10 x 95 DIN603 A2

Item: 022712504
 K&K Play structure

Order:

1293747

Location:

Building Project:

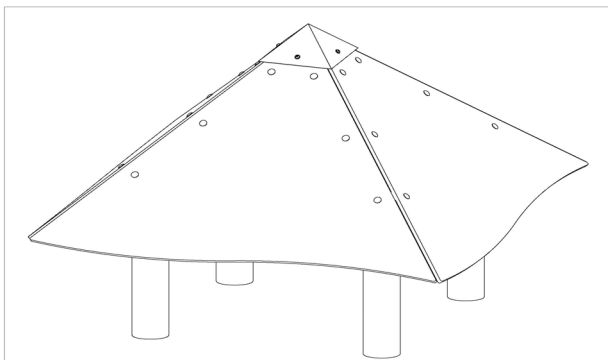
1 x SFAS1240007 Tent roof 4 x 0,80 m with hood

per SC	Total	K&K-Item	Marking
4 x	4 x	3430102	Washer Ø 8.4 DIN9021 A2
4 x	4 x	3400673	Dome head screw M8x20 A2 Security Torx TR40
24 x	24 x	3430011	Hexagon cap nut M10 DIN986 A2
24 x	24 x	3430014	Washer Ø 10,5 DIN125 form B A2
24 x	24 x	3400138	mushroom head screw square neck M10x30 DIN 60

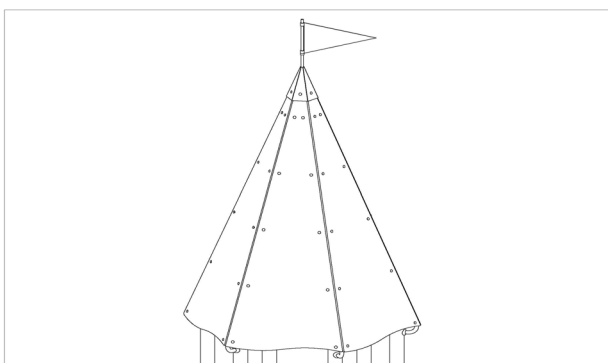
1 x SFAS1240012 Fastening of HPL panels with rounded edges to steel frame of tower-shaped roof 72°

per SC	Total	K&K-Item	Marking
60 x	60 x	3430014	Washer Ø 10,5 DIN125 form B A2
60 x	60 x	3430011	Hexagon cap nut M10 DIN986 A2
6 x	6 x	3400195	Dome head security screw-M10x30-Resistorx T45 A
6 x	6 x	3430086	Washer Ø 10,5 DIN9021 A2
60 x	60 x	3400138	mushroom head screw square neck M10x30 DIN 60

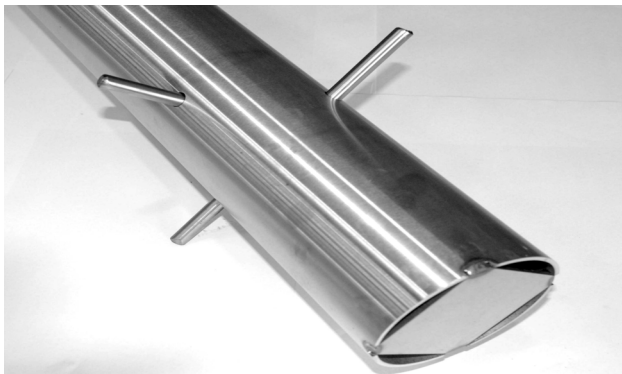
37 x SFES1270001 Reinforcing steel for stainless steel posts

per SC	Total	K&K-Item	Marking
2 x	74 x	2130000	Reinforcing steel Ø 10 x 310 DIN 488

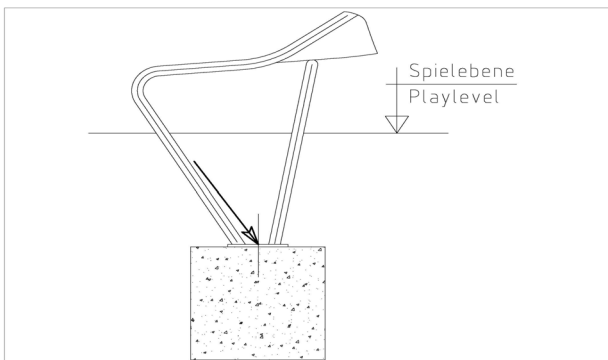
2 x SFAS1070006 Slide run-out section (up to 2,00 m) on foundation stone bolt assembly

per SC	Total	K&K-Item	Marking
2 x	4 x	1070365	Set of stone bolts for slide run-out section M12x160

Item: **022712504**
K&K Play structure

Order:

1293747

Location:

Building Project:

1 x SFWZ000001 Security TORX wrench TR40

per SC	Total	K&K-Item	Marking
1 x	1 x	3490081	Security TORX wrench TR40



1 x SFWZ000009 Hexagon insert socket driver 10mm 1/2" with borehole for Pin

per SC	Total	K&K-Item	Marking
1 x	1 x	2030170	Hexagon insert socket driver 10 mm 1/2" with drill hole for Pin



7 x SFWZ000012 Lubricating metal (30g box) incl. brush

per SC	Total	K&K-Item	Marking
1 x	7 x	5300039	Lubricating metal box 30g
1 x	7 x	5200026	Brush for lubricating metal

